



This report provided free of charge by:

**Upstream Enterprises, LLC**

3210 Motorsports Lane Unit 2  
Charlotte, NC 28269

(704) 352-6843



## Vehicle History Report™

US \$44.99

### 2013 PORSCHE 911 CARRERA S

VIN: WP0AB2A90DS122360  
COUPE  
3.8L H6 F 24V  
GASOLINE

This CARFAX Report  
Provided by:  
**Upstream Enterprises,  
LLC**

**Damage reported: minor damage**

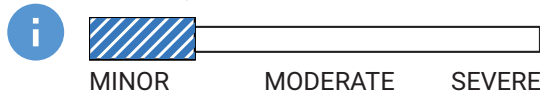

**4** Service history records

**2** Previous owners

Types of owners: Corporate, Personal

**39,132** Last reported odometer reading



This CARFAX Vehicle History Report is based only on information supplied to CARFAX and available as of 2/12/25 at 9:43:12 AM (CST). Other information about this vehicle, including problems, may not have been reported to CARFAX. Use this report as one important tool, along with a vehicle inspection and test drive, to make a better decision about your next used car.



### Accident / Damage History

Not all accidents / issues are reported

[^ Back To Top](#)

Event 1

05/30/2019

**Damage reported: minor damage**

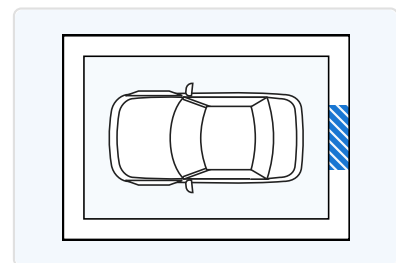
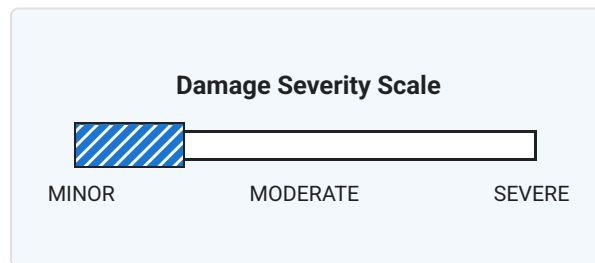

### Additional History

Not all accidents / issues are reported to CARFAX

<b>Total Loss</b> No total loss reported to CARFAX.	<input checked="" type="checkbox"/> No Issues Reported
<b>Structural Damage</b> CARFAX recommends that you have this vehicle inspected by a collision repair specialist.	<input checked="" type="checkbox"/> No Issues Reported
<b>Airbag Deployment</b> No airbag deployment reported to CARFAX.	<input checked="" type="checkbox"/> No Issues Reported
<b>Odometer Check</b> No indication of an odometer rollback.	<input checked="" type="checkbox"/> No Issues Indicated
<b>Accident / Damage</b> Damage reported: 05/30/2019.	Minor Damage
<b>Manufacturer Recall</b> No open recalls reported to CARFAX.	No Recalls Reported
<b>Basic Warranty</b> Original warranty estimated to have expired.	<b>Warranty Expired</b>



### Title History

CARFAX guarantees the information in this section

<b>Damage Brands</b> Salvage   Junk   Rebuilt   Fire   Flood   Hail   Lemon	<input checked="" type="checkbox"/> <b>Guaranteed</b> No Problem

**Odometer Brands**

Not Actual Mileage | Exceeds Mechanical Limits

**Guaranteed**

No Problem

**GUARANTEED** - None of these title problems were reported by a U.S. state Department of Motor Vehicles (DMV). If you find that any of these title problems were reported by a DMV and not included in this report, you may qualify.[View Terms](#) | [View Certificate](#)**Ownership History**

The number of owners is estimated

Year purchased

Type of owner

Estimated length of ownership

Owned in the following states/provinces

Estimated miles driven per year

Last reported odometer reading

**Detailed History****Owner 1**Purchased:  
2014**Low mileage!** This owner drove less than the industry average of 15,000 miles per year.Corporate  
Vehicle  
5,055 mi/yr

Date	Mileage	Source	Comments
12/25/2013	7,992	Pacific Volkswagen Hawthorne, CA 310-531-9400 pacificvolkswagen.com 4.2 / 5.0 269 Verified Reviews 5,636 Customer Favorites	<b>Vehicle offered for sale</b>
01/14/201	7,995	Porsche South Bay	<b>Vehicle serviced</b>

4

Torrance, CA  
424-488-0729  
porschesouthbay.com/

★ 4.6 / 5.0

41 Verified Reviews 

♥ 2 Customer Favorites



- 10,000 mile service performed
- Oil and filter changed
- Pre-purchase inspection completed
- Tire condition and pressure checked

04/23/201 8,043  
4

North Carolina  
Motor Vehicle Dept.  
Charlotte, NC

#### Odometer reading reported

- Titled or registered as corporate vehicle

05/08/201  
4

Porsche South Bay  
Torrance, CA  
424-488-0729  
porschesouthbay.com/

★ 4.6 / 5.0

41 Verified Reviews 

♥ 2 Customer Favorites



#### Vehicle serviced

07/02/201  
4

North Carolina  
Motor Vehicle Dept.  
Charlotte, NC  
Title  
#776829141834148

#### Title or registration issued

- First owner reported

05/17/201 13,431  
5

Dealer Inventory

#### Vehicle offered for sale



**Owner 2**  
Purchased:  
2015



**Low mileage!** This owner drove less than the industry average of 15,000 miles per year.

Personal  
Vehicle  
2,698 mi/yr

**Date**

**Mileage Source**

**Comments**

06/13/201 13,527  
5

North Carolina  
Motor Vehicle Dept.  
Charlotte, NC

#### Odometer reading reported

07/08/201  
5

North Carolina  
Motor Vehicle Dept.  
Charlotte, NC  
Title  
#77022215189663U

#### Title or registration issued

- New owner reported  
- Loan or lien reported

09/17/201  
5

North Carolina  
Motor Vehicle Dept.

#### Registration issued or renewed

- Loan or lien reported

Charlotte, NC  
Title  
#77022215189663U

10/03/201  
6

North Carolina  
Motor Vehicle Dept.  
Charlotte, NC  
Title  
#77022215189663U

**Registration issued or renewed**  
- Loan or lien reported

06/15/201 22,291  
7

Mp Motorwerks  
Charlotte, NC  
980-939-1563  
mpmotorwerks.com/



**Vehicle serviced**  
- Oil and filter changed

★ 4.9 / 5.0  
64 Verified Reviews   
❤️ 15 Customer Favorites

08/09/201  
7

North Carolina  
Motor Vehicle Dept.  
Charlotte, NC  
Title  
#77022215189663U

**Registration issued or renewed**  
- Loan or lien reported

09/07/201  
8

North Carolina  
Motor Vehicle Dept.  
Charlotte, NC  
Title  
#77022215189663U

**Registration issued or renewed**  
- Loan or lien reported

05/30/201  
9

Damage Report



**Damage reported: minor damage**  
- Damage to rear

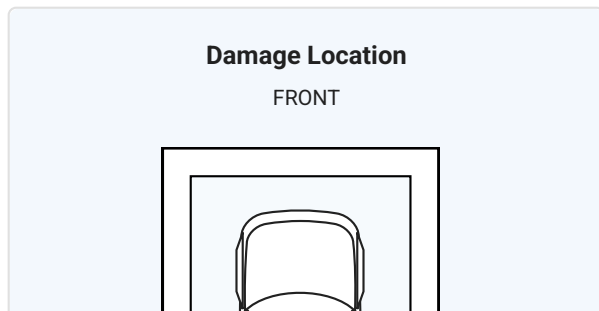
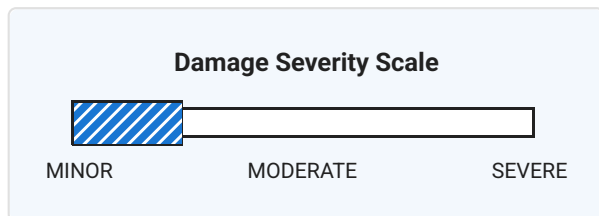

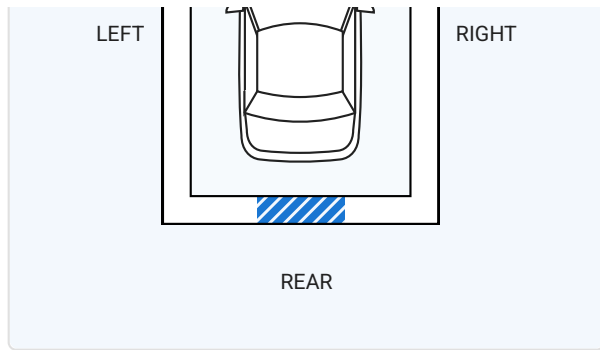

Minor damage is usually cosmetic, including dents or scratches to the vehicle body.

<p>08/31/2019</p>	<p>North Carolina Motor Vehicle Dept. Charlotte, NC Title #77022215189663U</p>	<p><b>Registration issued or renewed</b> - Loan or lien reported</p>
<p>05/01/2020</p>	<p>Porsche Cars North America</p>	<p><b>Manufacturer Voluntary Service Action issued</b> - Program #WLA4 RETROFITTING HEAT SHIELD</p> <p>Click here or call 1-800-PORSCHE to locate an authorized Porsche dealer near you.</p> <p><a href="#">⊕ Learn more about this campaign</a></p>
<p>05/05/2020</p>	<p>Porsche Cars North America</p>	<p><b>Manufacturer Voluntary Service Action issued</b> - Program #WLC8 REPLACING TANK LEAK DIAGNOSIS MODULE</p> <p>Click here or call 1-800-PORSCHE to locate an authorized Porsche dealer near you.</p> <p><a href="#">⊕ Learn more about this campaign</a></p>
<p>08/31/2020</p>	<p>North Carolina Motor Vehicle Dept. Charlotte, NC Title</p>	<p><b>Registration issued or renewed</b> - Loan or lien reported</p>

#77022215189663U

09/24/202  
1

North Carolina  
Motor Vehicle Dept.  
Charlotte, NC  
Title  
#77022215189663U

**Registration issued or renewed**  
- Loan or lien reported

07/07/202  
3

North Carolina  
Motor Vehicle Dept.  
Davidson, NC  
Title  
#77022215189663U

**Registration issued or renewed**  
- Loan or lien reported  
- Registration updated when owner  
moved the vehicle to a new  
location

09/19/202  
3

North Carolina  
Motor Vehicle Dept.  
Davidson, NC  
Title  
#77022215189663U

**Registration issued or renewed**  
- Loan or lien reported

12/05/202 39,132  
4

Valvoline Instant Oil  
Change  
Cornelius, NC  
704-892-9834  
vioc.com



**Vehicle serviced**  
- Emissions inspection performed

★ 4.8 / 5.0  
228 Verified Reviews ✓  
♥ 109 Customer  
Favorites

12/05/202  
4

North Carolina  
Motor Vehicle Dept.  
Davidson, NC  
Title  
#77022215189663U

**Registration issued or renewed**  
- Loan or lien reported



Avoid financial headaches. Make sure the loan has been paid off if you're buying from a private seller. [Learn More](#)

Have Questions? Consumers, please visit our Help Center at [www.carfax.com](http://www.carfax.com). Dealers or Subscribers, please visit our Help Center at [www.carfaxonline.com](http://www.carfaxonline.com).



Glossary

### **Damage Indicator**

Damage can be a result of many different types of events. Examples include contact with objects (other cars, trees, traffic signs, road debris, etc), vandalism, or weather-related events. Not every damage event is reported to CARFAX. As details about the damage event become available, those additional details are added to the CARFAX Vehicle History Report. CARFAX recommends that you have this vehicle inspected by a qualified mechanic.

- This CARFAX Vehicle History Report is based only on information supplied to CARFAX and available as of 2/12/25 at 9:43:12 AM (CST). Other information about this vehicle, including problems, may not have been reported to CARFAX. Use this report as one important tool, along with a vehicle inspection and test drive, to make a better decision about your next used car.

### **Damage Severity**

Damage events result in one of the following severity levels:

- Minor: Generally, minor damage is cosmetic (including dents or scratches), may only require reconditioning, and typically does not compromise a vehicle's operation and/or safety.
- Moderate: Moderate damage may affect multiple components of the vehicle and may impair the vehicle's operation and/or safety.
- Severe: Severe damage usually affects multiple components of the vehicle and is likely to compromise the vehicle's operation and/or safety.

CARFAX recommends getting a pre-purchase inspection at a certified collision repair facility.

### **First Owner**

When the first owner(s) obtains a title from a Department of Motor Vehicles as proof of ownership.

### **New Owner Reported**

When a vehicle is sold to a new owner, the Title must be transferred to the new owner(s) at a Department of Motor Vehicles.

### **Ownership History**

CARFAX defines an owner as an individual or business that possesses and uses a vehicle. Not all title transactions represent changes in ownership. To provide estimated number of owners, CARFAX proprietary technology analyzes all the events in a vehicle history. Estimated ownership is available for vehicles manufactured after 1991 and titled solely in the US including Puerto Rico. Dealers sometimes opt to take ownership of a vehicle and are required to in the following states: Maine, Massachusetts, New Jersey, Ohio, Oklahoma, Pennsylvania and South Dakota. Please consider this as you review a vehicle's estimated ownership history.

### **Service Campaign**

Automobile manufacturers issue a service campaign to address product technical issues that may not be related to safety or emissions standards. These issues are typically customer satisfaction initiatives.

Follow Us:



[facebook.com/CARFAX](https://facebook.com/CARFAX)



[@CARFAXinc](https://twitter.com/CARFAXinc)



[About CARFAX](#)

CARFAX DEPENDS ON ITS SOURCES FOR THE ACCURACY AND RELIABILITY OF ITS INFORMATION. THEREFORE, NO RESPONSIBILITY IS ASSUMED BY CARFAX OR ITS AGENTS FOR ERRORS OR OMISSIONS IN THIS REPORT. CARFAX FURTHER EXPRESSLY DISCLAIMS ALL WARRANTIES, EXPRESS OR IMPLIED, INCLUDING ANY IMPLIED WARRANTIES OF MERCHANTABILITY OR FITNESS FOR A PARTICULAR PURPOSE.

© 2025 CARFAX, Inc., part of S&P Global. All rights reserved.  
2/12/25 9:43:12 AM (CST)



I have reviewed and received a copy of the CARFAX Vehicle History Report for this 2013 PORSCHE 911 vehicle (VIN: WP0AB2A90DS122360), which is based on information supplied to CARFAX and available as of 2/12/25 at 10:43 AM (EST).

---

**Customer Signature**

**Date**

---

**Dealer Signature**

**Date**